Installation and Service Guide

Publication number 16500-97008
Second edition, April 1994

For Safety information, Warranties and Regulatory information, see the pages
behind the index

©Copyright Hewlett-Packard Company 1994
All Rights Reserved

HP 16500L Interface Module

Using an HP 16500B on the Network

The HP 16500L LAN Interface Module gives you fast, easy access to the HP 16500B Logic Analysis System via a Local Area Network (LAN).

From a computer on the LAN, you can:

- Set up and run measurements using the HP 16500B's X Window interface.
- Copy measurement data from the HP 16500B to your computer.
- Save and restore HP 16500B system and module configurations.
- Program the HP 16500B.

Requirements

In order to use the HP 16500B Logic Analysis System on the LAN, you need the following equipment and software:

- HP 16500B Logic Analysis Mainframe.
- HP 16500L LAN Interface Module.
- Ethernet local area network using TCP/IP protocol.
- A Media Access Unit (MAU) to connect the HP 16500L to your network.

If you are using a PC:

- NFS protocol program or File Transfer Protocol (FTP) program.

If you want to use the HP 16500B's X Window interface:

- X Window server program running on your computer.

In This Book

This book shows you how to use the HP 16500B via a Local Area Network (LAN) connection. This book contains the following chapters:

- Chapter 1 shows you how to access the HP 16500B's file system. This is a prerequisite for some of the other things you can do with an HP 16500B on the network.
- Chapter 2 shows you how to display the HP 16500B interface on an X Window server, and it describes the basics about using the interface.
- Chapter 3 shows you how to retrieve measurement data, screen images, and status information from an HP 16500B on the Local Area Network (LAN).
- Chapter 4 shows you how to copy and restore module configurations.
- Chapter 5 shows you methods for programming the HP 16500B via the network connection.
- Chapter 6 contains additional information on the HP 16500B's directory structure, dynamic files, and new menus for HP 16500L.
- Chapter 7 describes what to do if you have a problem using the HP 16500L.

1	Accessing the HP 16500B File System	
2	Using the HP 16500B X Window Interface	
3	Retrieving and Restoring Measurement Data	
4	Configuring HP 16500B Modules	
5	Programming the HP 16500B	
6	Concepts	
7	If You Have a Problem	
	Glossary	
	Index	

See Also

The *HP 16500L LAN Interface Module Administrator's and Service Guide* for information on installing and setting up the HP 16500L.

The *Logic Analyzer Training Kit* if you are unfamiliar with the basic operation of the HP 16500B system.

UNIX® is a registered trademark of UNIX Systems Laboratories, Inc. in the U.S.A. and other countries.

MS® and MS-DOS® are U.S. registered trademarks, and Windows is a trademark of Microsoft Corporation.

PC-NFS® is a registered trademark of Sun Microsystems, Inc. in the United States and in other countries.

Contents

1 Accessing the HP 16500B File System

- To mount the file system via NFS 1-4
- To access the file system via FTP 1-9

2 Using the HP 16500B X Window Interface

- To start the interface 2-4
- To close the interface 2-9
- To load the custom fonts 2-11
- X Window Display Anomalies 2-14

3 Retrieving and Restoring Measurement Data

- To copy ASCII measurement data 3-3
- To copy raw measurement data 3-5
- To restore raw measurement data 3-6
- To strip LIF structure from raw measurement data 3-7
- To copy screen images from \system\graphics 3-9
- To copy status information from \status 3-11

4 Configuring HP 16500B Modules

- To copy module configurations from setup.raw 4-3
- To restore module configurations 4-4

5 Programming the HP 16500B

- To set up for Ethernet programming 5-4
- To enter commands directly, using TELNET 5-6
- To copy commands to \system\program 5-7
- To write programs that open \system\program 5-9
- To write programs that open the command parser socket 5-12

6 Concepts

- HP 16500B File System Directory Structure 6-3
- Dynamic Files 6-8
- New Menus for HP 16500L 6-9

7 If You Have a Problem

- If you cannot connect to the HP 16500B 7-2
- If you cannot mount the HP 16500B file system 7-3
- If you cannot access the HP 16500B file system via FTP 7-3
- If you cannot start the X Window interface 7-4
- If you cannot copy files from HP 16500B 7-4
- If you cannot restore raw files 7-5
- If you cannot TELNET to the command parser SOCKET 7-5
- If you get an "operation timed-out" message 7-6
- If the HP 16500B begins to operate slowly 7-6
- If all else fails 7-6



Accessing the HP 16500B File System

Accessing the HP 16500B File System

This chapter shows you how to:

- Mount the file system via NFS.
- Access the file system via FTP.

This chapter assumes that the HP 16500B mainframe is physically connected to your local area network. If it is not connected, refer to the *HP 16500L Administrator's and Service Guide* for information on how to connect the system.

Control User vs. Data User

You can access the HP 16500B file system as either the control user or a data user.

Control User

- The control user can send programming commands to the HP 16500B.
- The control user has read and write access to the HP 16500B file system.
- There can only be one control user at any time. If you attempt to access the HP 16500B file system as the control user when another control user is already accessing the HP 16500B, or when someone is using TELNET to access the command parser SOCKET, the access will fail.

Data User

- The data user cannot send programming commands to the HP 16500B.
- The data user has read-only access to the HP 16500B file system, except under the `\system\disk\hard` and

\system\disk\flexible directories (the HP 16500B disk drives) where read-write access is permitted.

- Multiple data users can access the HP 16500B.

Password and File Protection

There is no password protection built into the HP 16500L. The HP 16500B operating system files, under the subdirectory `system` on the HP 16500B hard disk, are not write protected.

CAUTION

Do not delete the operating system files. If the files are deleted, the HP 16500B will not operate the next time it is re-booted. If you accidentally delete any of these files, copy them from the flexible disks labeled "16500 Operating System" back onto the hard disk, into the directory called `\system`.

To mount the file system via NFS

The HP 16500B must be turned ON and completely booted up before you can mount the file system. Once power is applied to the HP 16500B and the System Configuration menu is displayed, allow an additional 15 seconds before attempting to mount the system.

Be sure to unmount the HP 16500B's file system before turning the HP 16500B's power OFF. If you don't do this, you may get a "stale NFS file handle" error message the next time you try to mount. If you get this message, unmount the file system and try mounting again.

From Computers Running the UNIX Operating System

The syntax of the mount command is typically:

```
mount [symbolic name|IP address]:/[control|data] /[directory name]
```

The symbolic name is the host name of the HP 16500B as set up by your system administrator. Typically, this name is found in the `/etc/hosts` file on your computer or returned by a name server. It is equivalent to the HP 16500B's IP (Internet Protocol) address.

The control or data option specifies the type of user you want to access the HP 16500B as.

The directory name is the name of an empty directory in your computer's file system to which the HP 16500B's file system will be mounted.



Example

To mount, as the control user, the HP 16500B named "16500sys" to a directory on your computer named "/logic", enter the following command at the UNIX command line:

```
mount 16500sys:/control /logic
```

After you have entered this command, you will be able to see the HP 16500B's file system under the /logic directory on your computer.

To unmount:

```
umount /logic
```

From Computers Running the MS-DOS Operating System

To use the HP 16500L in an MS-DOS environment, you need to install a program on your PC that allows you to use NFS protocol. One example is PC-NFS by SunSoft Inc.

To mount the HP 16500B file system from a PC running MS-DOS, you must create a logical drive that points to the HP 16500B file system. A typical MS-DOS command to do this would look like one of these two examples:

```
net use [drive name] [host name|IP address]:/[control|data]
```

```
net use [drive name] \\[host name|IP address]\\[control|data]
```

The choice of drive name is up to you.

The host name of the HP 16500B is set up by your system administrator. Typically, this name is found in the hosts file on your computer or returned by a name server. It is equivalent to the HP 16500B's IP (Internet Protocol) address.

The control or data option specifies the type of user you want to access the HP 16500B as.

Example

To mount, as the control user, the HP 16500B whose IP address is "15.6.254.150" to the logical drive "L:", enter the following command at the MS-DOS prompt. In this example, the PC-NFS® application is used.

```
net use L: 15.6.254.150:/control
```

After you have entered this command, you will be able to see the HP 16500B's file system under the "L:" logical drive on your computer.

To unmount:

```
net use L: /d
```

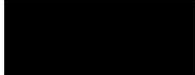

From Computers Running MS Windows

To use the HP 16500L in an MS Windows environment, you need to install a program on your PC that allows you to use NFS protocol. One example is PC-NFS by SunSoft Inc.

To mount the HP 16500B's file system from a PC running MS-Windows, use the Network Connections menu in the Disk options of File Manager.

Example

To connect to the HP 16500B system from the File Manager in MS-Windows, Version 3.1, perform the following steps:

- 1 Open File Manager and select Disk. Then, select Network Connections.



- 2 In the "New Connection" section of the pop-up menu, click on the Drive Letter selection box and select the drive name you wish to use.

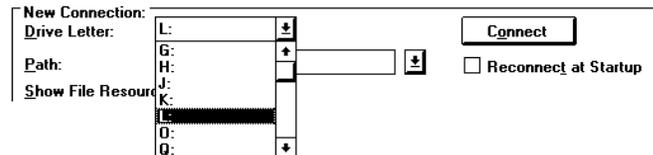



- 3 In the Path field, type the name of the server that the HP 16500B system is mounted on, followed by the HP 16500's name or IP address. At the end of the path, specify which kind of connection you would like to establish, either "control" or "data".

New Connection:	
Drive Letter:	L: <input type="text" value="L"/> 
Path:	<input type="text" value="\\server1\logic:/control"/>  <input type="checkbox"/> Reconnect at Startup
<input type="button" value="Connect"/>	

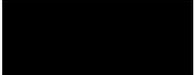

To access the file system via FTP

To access the HP 16500B's file system using ftp, enter the following command on your computer:

```
ftp [symbolic name|IP address]
```

The symbolic name is the host name of the HP 16500B as set up by your system administrator. Typically, this name is found in the hosts file on your computer or returned by a name server. It is equivalent to the HP 16500B's IP (Internet Protocol) address.

When the connection is made, you will be prompted for a login name. Enter "control" or "data" depending on the type of user you want to access the HP 16500B as.

If you are prompted for a password, just press the Return or Enter key. There is no password protection built into the HP 16500L.

Example

To access, using ftp, the file system of the HP 16500B named "16500sys", enter:

```
ftp 16500sys
```

```
login name: control
```





Using the HP 16500B X Window Interface

Using the HP 16500B X Window Interface

This chapter shows you how to:

- Start the interface.
- Close the interface.
- Load the custom fonts.

Supported HP 16500B Modules

Not all HP 16500B modules are supported in the X Window interface. However, the more recent modules, including those shown below, are supported.

- HP 16517A and HP 16518A Ultra High Speed Timing modules.
- HP 16520A and HP 16521A Pattern Generator modules.
- HP 16532A Oscilloscope module.
- HP 16542A State Analyzer module.
- HP 16550A State/Timing Analyzer module.
- HP 16555A State/Timing Analyzer module.

Using the Mouse and Keyboard

Once you have started the X Window interface and are displaying it on your computer running the X server, you can use your computer's keyboard and mouse to control the logic analyzer interface in the same way you use the keyboard and mouse that can be connected to the HP 16500B. Refer to the *HP 16500B Logic Analysis System User's Reference* for a complete description of keyboard and mouse operation.

Selecting Fields and Menus

Move the mouse pointer over the field and click the left mouse button.

Or, use the keyboard's tab or arrow keys to highlight a field and use the carriage return key to make the selection.

Duplicating Front-Panel Knob Movement

Hold down the center mouse button, and move the mouse up or to the right to duplicate clockwise knob movement; move the mouse down or to the left to duplicate counter-clockwise knob movement.

Or, use the keyboard's Shift-up or -right arrow keys to duplicate clockwise knob movement; use the Shift-down or -left arrow keys to duplicate counter-clockwise knob movement.



To start the interface

From a Remote Computer

- 1 On your X server, enable HP 16500B initiated windows.

Most X server packages have a security feature which stops unwanted client-initiated windows from being displayed.

On computers running the UNIX operating system, you can enable HP 16500B initiated with the `xhost` command:

```
xhost +<HP 16500B IP address>
```

On computers that aren't running the UNIX operating system, the X server package documentation will explain its security features.

- 2 Send the XWIN ON programming command to the HP 16500B.

The syntax of the XWIN ON command is:

```
xwin on,"<X server IP address>:<display>.<screen>"
```

The IP (Internet Protocol) address is the address of the X Windows server.

Example

To enable windows to be initiated from the HP 16500B named lp16500b, enter the following command on the computer running the X server (and the UNIX operating system in this example):

```
xhost +lp16500b
```

To connect to the command parser socket of the HP 16500B named "lp16500b", enter:

```
telnet lp16500b 5025
```

Now, to start the X Window interface on the computer, whose IP address is 15.6.253.146 (and is running the X server), enter:

```
xwin on, "15.6.253.146:0.0"
```

The window below appears on the computer running the X server.

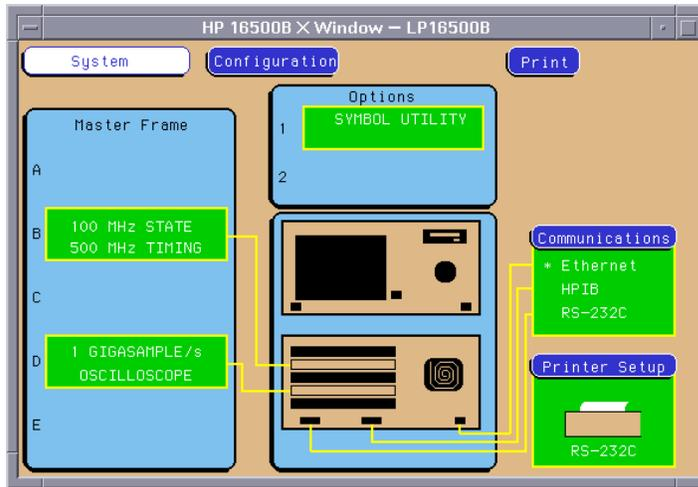

Using the HP 16500B X Window Interface

To start the interface

Example

To enable windows to be initiated from the HP 16500B named lp16500b, enter the following command on the computer running the X server (and the UNIX operating system in this example):

```
xhost +lp16500b
```

If you have mounted the HP 16500B's file system to a directory named "/logic" on your computer whose IP address is 15.6.253.146 (and is running the UNIX operating system and the X server), enter the following command to start the X Window interface:

```
echo "xwin on, '15.6.253.146:0.0'" > /logic/system/program
```

Example

To start the HP 16500B's X Window interface and display on a personal computer running X server software, first start the X server software (and enable HP 16500B initiated windows, if necessary).

If you have mounted the HP 16500B's file system to the logical drive "L:" on your computer whose IP address is 15.6.253.146 (and is running the X server), enter the following command to start the X Window interface:

```
echo xwin on, "15.6.253.146:0.0" > L:\system\program
```

From the HP 16500B Front Panel



- 1 Start the X server software on your host computer.
- 2 On your X server, enable HP 16500B initiated windows.

Most X server packages have a security feature which stops unwanted client-initiated windows from being displayed.

On computers running the UNIX operating system, you can enable HP 16500B initiated with the `xhost` command:

```
xhost +<HP 16500B IP address>
```

On computers that aren't running the UNIX operating system, the X server package documentation will explain its security features.

- 3 In the HP 16500B's System Configuration menu, select the Communications field. Then, select the X Window field.

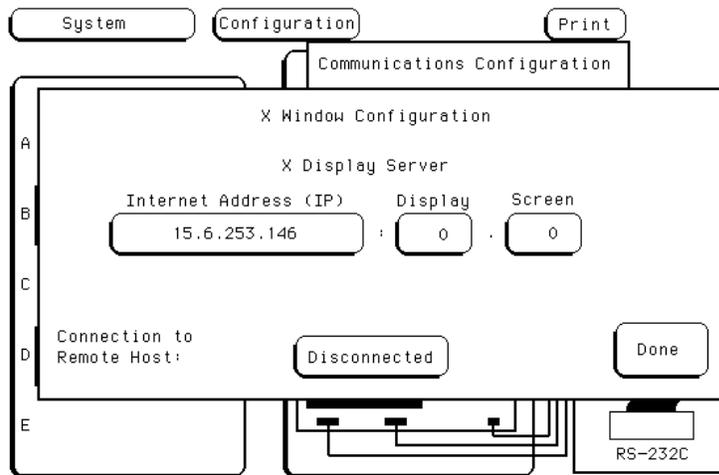

To start the interface



- 4 Enter the Internet Address of the X Windows server, the Display, and the Screen values; then, select the Disconnected field.

The interface starts on your X server, and the Disconnected field changes to Connected.

To close the interface

From the HP 16500B X Window Interface or Front Panel

- 1 In the System Configuration menu, select the Communications field. Then, select the X Window field.

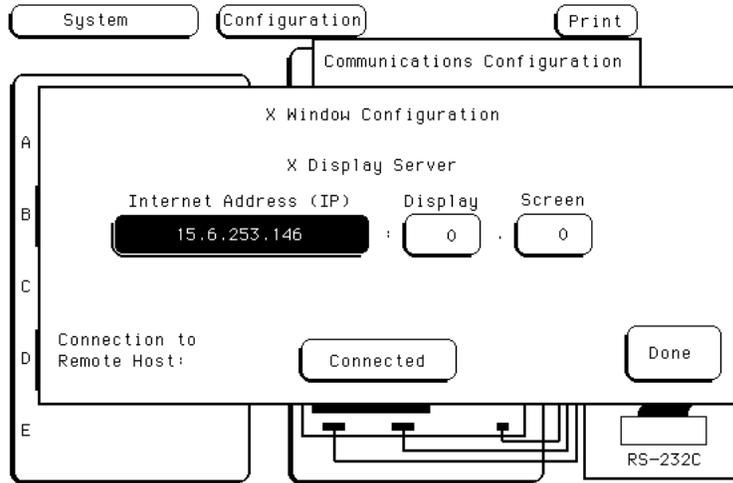

- 2 Select the Connected field.

The interface on your X server closes, and the Connected field changes to Disconnected.

From a Remote Computer

- Send the XWIN OFF programming command to the HP 16500B.

Note that simply closing the window that the interface is running in may leave the HP 16500B hung up.

Using the HP 16500B X Window Interface
To close the interface

Example

To connect to the command parser socket of the HP 16500B named "16500sys", enter:

```
telnet 16500sys 5025
```

Now, to close the X Window interface, enter:

```
xwin off
```

Example

If you have mounted the HP 16500B's file system to a directory named "/logic" on your computer, enter the following command to close the X Window interface:

```
echo 'xwin off' > /logic/system/program
```

To load the custom fonts

- 1** From the computer running your X server software, access the HP 16500B's file system.

Refer to the "Accessing the HP 16500B File System" chapter.

- 2** Copy the SM165.BDF and LG165.BDF files from the HP 16500B's `\system\disk\hard\system` directory to a directory on your computer.

These font files may also be copied from the HP 16500B Operating System (version 2.00 or greater) media.

- 3** Set up the X server so that it can read these fonts.

Refer to your X Windows server documentation for instructions on loading and using custom fonts. Generally, the steps you will take are:

- a** Compile the .BDF files into the proper format.
- b** Build the font directory (FONTS.DIR) file.
- c** If the font directory is not in the current font path, add the new directory to the font path.

The custom fonts make the HP 16500B's X Window interface look identical to the instrument's display. If the custom fonts are not loaded, you will see odd characters in place of arrow symbols and may see out-of-bounds text in the X Window image.

Example

Suppose the computer running your X server software is also running the UNIX operating system.

Change to the directory where you want to install the custom font files.

```
cd /users/guest/165fonts
```

As the data user, access, via FTP, the file system of the HP 16500B named lp16500b. Then, copy the SM165.BDF and LG165.BDF files from the HP 16500B's \system\disk\hard\system directory to your computer.

```
ftp lp16500b
220 HP16500B V01.00 FUSION FTP server (Version 3.3) ready.
Name (lp16500b:guest): data
230 User DATA logged in.
ftp> cd /system/disk/hard/system
200 Remote Directory changed to "/system/disk/hard/system".
ftp> get lg165.bdf
200 PORT command ok.
150 Opening data connection for lg165.bdf (15.6.253.146,1121)
(20494 bytes).
226 Transfer complete.
23338 bytes received in 0.69 seconds (32.82 Kbytes/s)
ftp> get sm165.bdf
200 PORT command ok.
150 Opening data connection for lg165.bdf (15.6.253.146,1122)
(19595 bytes).
226 Transfer complete.
22311 bytes received in 0.32 seconds (68.04 Kbytes/s)
ftp> quit
```

To create a fonts.dir file in the current directory:

```
mkfontdir
```

To prepend the current directory to the font path:

```
xset +fp /users/guest/165fonts
```

To reset the font path to its current value:

```
xset fp rehash
```

Close the HP 16500B's X Window interface and re-start it. You should now see the same fonts that are used on the HP 16500B's front panel display.

The xset commands must be repeated each time that X11 is restarted. To overcome this, simply install the fonts in the default X11 font directory,

typically found in `/usr/lib/X11/fonts/misc`; this directory is usually protected, so your system administrator may have to perform the installation.





X Window Display Anomalies

Color

The X Window Interface software emulates the HP 16500B display's base, popup, alpha, and inverse planes. The base and popup planes are emulated pretty well, but the inverse and alpha planes do not always look quite right. There is little that can be done about strange colors in the inverse and alpha planes.



Retrieving and Restoring Measurement Data

Retrieving and Restoring Measurement Data

This chapter shows you how to:

- Copy ASCII measurement data.
- Copy raw measurement data.
- Restore raw measurement data.
- Strip LIF structure from raw measurement data.
- Copy screen images from `\system\graphics`.
- Copy status information from `\status`.

Measurement data is available in binary format and also in ASCII format for some measurement modules. Screen images are available in TIFF, PCX, and Encapsulated Postscript formats.

To copy ASCII measurement data

ASCII data files are not available for all measurement modules.

- 1** Set up the module for the measurement you want to make, and run the analyzer to acquire data.
- 2** Access the HP 16500B's file system.

Refer to the "Accessing the HP 16500B File System" chapter.

You can do this from the HP 16500B's X Window interface or front panel, or by programming the HP 16500B.

- 3** Copy the measurement data from the `\slot_{x}\data.asc` subdirectory.

In the HP 16500B's file system, ASCII data files are located in `\slot_{x}\data.asc\{analyzer name}\{label name}.txt`.

Depending on the measurement module, there may or may not be an analyzer name subdirectory.

There is an ASCII data file corresponding to each label name you have created in the measurement module.

The data files for each label are overwritten by the analyzer each time new data is acquired.

Retrieving and Restoring Measurement Data
To copy ASCII measurement data

Example

Suppose you have an HP 16550A State/Timing Analyzer installed in slot C of your HP 16500B mainframe. The name of analyzer 1 of the HP 16550A is 68000_BUS. You have created some labels under analyzer 1 of the HP 16550A, including one called "addr_lo." The directory structure of the HP 16500B system looks like this:

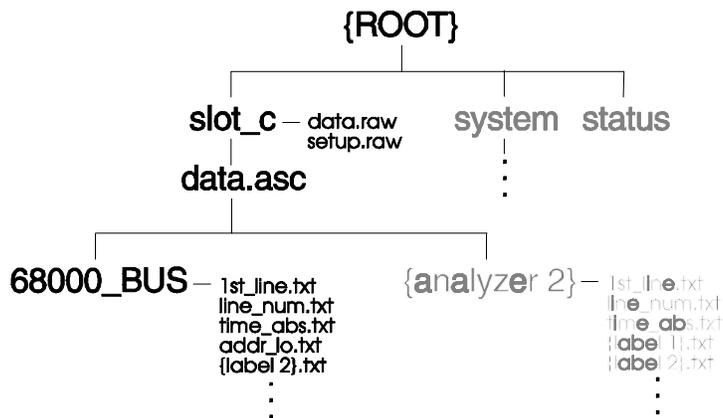

After setting up a measurement and acquiring data, you want to analyze the data for label addr_lo on your PC. To copy the ASCII data to your local computer, at the MS-DOS prompt enter:

```
copy L:\slot_c\data.asc\68000_BUS\addr_lo {local path name}
```

If your computer is running the UNIX operating system, you might use the cp command. In an MS Windows environment, you can use File Manager.

To copy raw measurement data

- 1** Set up the module for the measurement you want to make, and run the analyzer to acquire data.

You can do this from the HP 16500B's X Window interface or front panel, or by programming the HP 16500B.

- 2** Access the HP 16500B's file system.

Refer to the "Accessing the HP 16500B File System" chapter.

- 3** Copy the `data.raw` file from the appropriate `\slot_{x}` directory.

Raw measurement data files are binary format files that can be transferred to your computer and then reloaded into the HP 16500B system later.

The `data.raw` file is overwritten each time new data is acquired.

To restore raw measurement data

- 1 Access the HP 16500B's file system as the control user.

Refer to the "Accessing the HP 16500B File System" chapter.

- 2 Copy the `data.raw` file to the appropriate `\slot_{x}` directory.

To strip LIF structure from raw measurement data

- Write a program that strips LIF structure from raw data files.

You may want to convert the `data.raw` file into a format that is consistent with the file format transmitted from the HP 16500B via HP-IB. The following example program will perform this conversion.

The `data.raw` File Format

The format of the `data.raw` file is similar to the file format described in the *Programmer's Guide* or *Programmer's Reference* for the measurement module that you are working with.

The `data.raw` file consists of a 512-byte header, followed by one or more 256-byte records. The first 36 bytes of the first record are reserved. The remaining 220 bytes of the first record contain data. The first 2 bytes of each additional record are reserved. The remaining 254 bytes of each record contain data.

Retrieving and Restoring Measurement Data
To strip LIF structure from raw measurement data

Example

This C-language program strips the LIF structure from the data.raw file.

```
#include <stdio.h>

main( argc, argv )
int argc ;
char *argv[] ;
{
    char buffer[256] ;
    int len ;
    int count = 0 ;

    while ( ( len = read( 0, buffer, 256 ) ) > 0 ) {
        count++ ;
        switch ( count ) {
            case 1:
            case 2:
                /* do nothing -- just throw away */
                break;
            case 3:
                /*
                ** throw away the first two bytes ( record size )
                **   the next four bytes ( file type ? )
                **   the next 32 bytes ( file description )
                */
                if ( len - 38 > 0 )
                    write( 1, &buffer[38], len-38 ) ;
                break;
            default:
                /* throw away the first two bytes ( record size )
                */
                len = (unsigned char)buffer[1] ;
                if ( len > 0 )
                    write( 1, &buffer[2], len ) ;
                break;
        }
    }
}
```

To copy screen images from \system\graphics

1 Access the HP 16500B's file system.

Refer to the "Accessing the HP 16500B File System" chapter.

2 Set up the screen you want to copy.

3 Copy the screen image file from the \system\graphics directory.

The \system\graphics directory contains the following files:

- screen.tif - a color TIFF file, in TIFF version 5.0 format.
- screenbw.tif - a black and white TIFF file in TIFF version 5.0 format.
- screen.pcx - a color PCX file.
- screenbw.epi - a black and white Encapsulated PostScript file in EPS version 3.0 format.

These graphics files contain the current display on the HP 16500B screen. The contents of the files change whenever you change the display. When you copy one of the graphics files, the display will freeze for a few moments to make a copy of the current display.

Example

To copy the current screen image in PCX format to a computer running the UNIX operating system, enter:

```
cp /logic/system/graphics/screen.pcx {local path name}
```

If your computer is running the MS-DOS operating system, you might use the copy command.

Example

To import a color .PCX graphics file into an MS Windows based bitmap editor, perform the following steps:

- 1 Select FILE, OPEN
- 2 Select the graphics subdirectory `L:\system\graphics`
- 3 Double-click on the file `screen.pcx`

To copy status information from \status

1 Access the HP 16500B's file system.

Refer to the "Accessing the HP 16500B File System" chapter.

2 Copy the appropriate file from the \status directory.

The \status directory contains the following ASCII files:

- `system.txt` - shows which modules are running and which are stopped. Also, it includes information about which modules are assigned to the Group Run in the Intermodule menu and the relative trigger times of each module.
- `frame.txt` - shows which modules are installed in the slots of your HP 16500B system and the version of operating system code for each module.
- `mount.txt` - shows the hosts that the HP 16500B is currently mounted on and whether it's a control user access or data user access.

Example

An example `system.txt` file:

```
Analyzer name: 16500SYS
```

```
Execution Status:  
  slot_a - stopped  
  slot_c - running  
  slot_d - running
```

```
Intermodule Tree:  
  slot_a armed by Group Run  
  slot_c armed by slot_a
```

```
Relative Trigger Times:  
  slot_a          0.05 s
```

Retrieving and Restoring Measurement Data
To copy status information from \status

Example

An example frame.txt file:

Analyzer name:16500SYS

Slot	Module Name	Code Version	Card ID Code
=====	=====	=====	=====
CPU	System	V02.00	
slot_a	Pattern Gen	V02.00	021
slot_d	100/500MHz LA	V02.00	032

Example

An example mount.txt file:

Analyzer name: 16500SYS

Hostname	UID	GID	Directory
=====	=====	=====	=====
pcl	-00002	-00002	/data
PARSER SOCKET	00000	00000	/control
raid3	00000	00003	/data
FTP: (15.19.3.98,1075)	00000	00000	/data



Configuring HP 16500B Modules

Configuring HP 16500B Modules

This chapter shows you how to:

- Copy module configurations from setup.raw.
- Restore module configurations.

You can also configure modules by programming the HP 16500B (refer to the "Programming the HP 16500B" chapter).

To copy module configurations from setup.raw

1 Set up the module configuration.

You can do this from the HP 16500B's X Window interface or front panel.

2 Access the HP 16500B's file system.

Refer to the "Accessing the HP 16500B File System" chapter.

3 Copy the `setup.raw` file from the appropriate `\slot_{x}` directory.

Raw configuration files are binary format files that can be transferred to your computer and then reloaded into the HP 16500B system later.

The `setup.raw` file is overwritten whenever you change the configuration of the measurement module.

You can copy HP 16500B system and Intermodule Bus configurations by copying the `\setup.raw` file to your computer.

To restore module configurations

- 1 Access the HP 16500B's file system as the control user.

Refer to the "Accessing the HP 16500B File System" chapter.

- 2 Copy the `setup.raw` file to the appropriate `\slot_{x}` directory.

You can restore HP 16500B system and Intermodule Bus configurations by copying files from your computer to `\setup.raw`.

Example

Suppose you want to load a configuration file called "486_bus" from your local computer into an HP 16550A state/timing module. The HP 16550A is installed in slot B of the HP 16500B mainframe. The mainframe is mounted on your network as disk drive L:

To load the configuration file, at the MS-DOS prompt enter:

```
copy 486_bus L:\slot_b\setup.raw
```

If your computer is running the UNIX operating system, you might use the `cp` command. In an MS Windows environment, you can use File Manager.



Programming the HP 16500B

Programming the HP 16500B

You can program the HP 16500B over the Local Area Network (LAN) by sending commands to the `\system\program` file or by sending commands to the command parser socket.

This chapter shows you how to:

- Set up for Ethernet programming.
- Enter commands directly, using TELNET.
- Copy commands to `\system\program`.
- Write programs that open `\system\program`.
- Write programs that open the command parser socket.

The HP 16500L does not provide real-time programming control. Due to the message handling protocol of the Ethernet LAN, messages take varying, indeterminate amounts of time to reach their destinations. There can be no guarantee that commands sent from your computer will reach the HP 16500B in a timely way.

For information on the HP 16500B's programming commands, refer to the *HP 16500B System Programmer's Guide*.

The `\system\program` File

Once you have accessed the HP 16500B's file system as the control user, you can send programming commands by copying text strings to the `\system\program` file. You can do this in the same way that any text string is copied to a file (for example, by re-directing the output of an echo command, by copying a file, by writing a program that opens the file and outputs strings, etc.).

The `\system\program` file provides a port into the HP 16500B command parser.

The Command Parser Socket

You can TELNET to the HP 16500B command parser socket and send programming commands directly, or you can write a program that opens the socket and sends commands to it.

Connection to the command parser socket is, by definition, a control user connection. Because only one control user connection is allowed, you will not be able to connect to the command parser socket if someone else is accessing the HP 16500B's file system as the control user.



To set up for Ethernet programming

Before you can send programming commands to the HP 16500B via the LAN, you must set up Ethernet communications from the HP 16500B front panel.

- 1 In the System Configuration menu, select the Communications field.

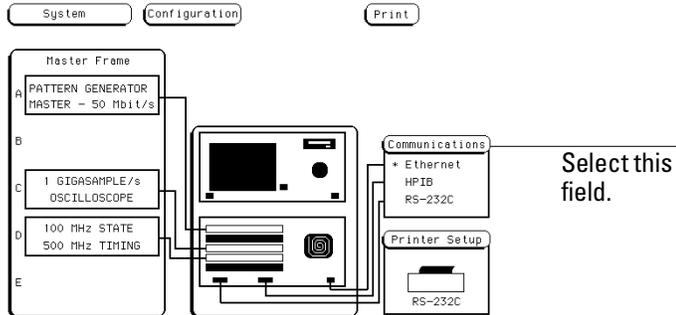

- 2 Select the Controller Selection field, then select Ethernet from the pop-up menu.

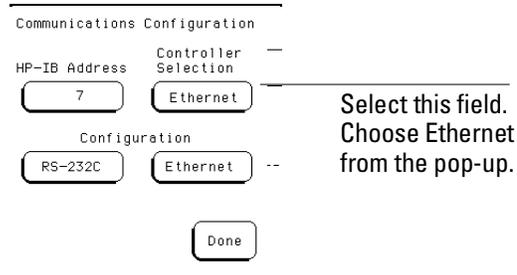

- 3 Select Done. Your Communications status display in the System Configuration Menu will look like this:

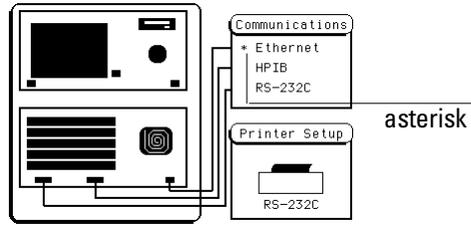

The asterisk next to the word "Ethernet" indicates that the Ethernet port has been selected to be the controller port. This prevents commands from being accepted by the HP 16500B via HP-IB or RS-232.

To enter commands directly, using TELNET

The syntax of the TELNET command is:

```
telnet [symbolic name|IP address] 5025
```

The symbolic name is the host name of the HP 16500B as set up by your system administrator. Typically, this name is found in the hosts file on your computer or returned by a name server. It is equivalent to the HP 16500B's IP (Internet Protocol) address.

5025 is the HP 16500B command parser socket port identification number. It must be specified.

The HP 16500B is not a fully functional TELNET server and, due to this, the socket number 5025 must be specified.

Example

To connect to the command parser socket of the HP 16500B named "16500sys", enter:

```
telnet 16500sys 5025  
Trying...  
Connected to 16500sys.col.hp.com.  
Escape character is '^]'
```

You can now type HP 16500B commands directly. The results of queries will appear on the command line of your PC or workstation.

To copy commands to \system\program

- 1 Access the HP 16500B's file system as the control user.

Refer to the "Accessing the HP 16500B File System" chapter.

- 2 Copy program command strings to the HP 16500B's \system\program file.

When the HP 16500B's file system is NFS mounted to your computer's file system, you can:

- Re-direct the output of an echo command to the \system\program file.
- Copy a text file containing a series of commands to the \system\program file.

When accessing the HP 16500B's file system via FTP, you can:

- Use FTP's put command to copy a text file containing a series of commands to the \system\program file.

Example

Suppose an HP 16550A state/timing analyzer is installed in slot C (slot 3) of your HP 16500B mainframe. To clear the trigger set-up on the HP 16550A, enter the following echo commands at the MS-DOS prompt:

```
echo :SELECT 3 > L:\system\program
```

```
echo :MACHINE1:STRIGGER:CLEAR ALL > L:\system\program
```

The first command selects the state/timing analyzer in slot C. The second command clears the trigger.

If your computer runs the UNIX operating system, you can use the UNIX echo command.

Example

Suppose an HP 16550A state/timing analyzer is installed in slot C (slot 3) of your HP 16500B mainframe. To clear the format and trigger set-ups on the HP 16550A, first type the following commands into an ASCII text file.

File clear.txt:

```
:SELECT 3
:MACHINE1:SFORMAT:REMOVE ALL
:MACHINE1:STRIGGER:CLEAR ALL
```

The first command selects the state/timing analyzer in slot C to receive programming commands. The second command clears the format set-up. The third command clears the trigger set-up.

Now copy the file to the HP 16500B system. At the MS-DOS prompt, enter:

```
copy clear.txt L:\system\program
```

If your computer runs the UNIX operating system, you might use the `cp` command. In an MS Windows environment, you can use File Manager.

To write programs that open `\system\program`

- 1 Using NFS, mount the HP 16500B's file system as the control user.

Refer to the "Accessing the HP 16500B File System" chapter.

- 2 From within your controlling C or BASIC program, open the file `\system\program` and send text strings to the file using "write" or "output" commands.

In C-language, you can use the `write` or `putstr` functions to write text strings to the `\system\program` file.

Your operating system may buffer the commands before sending them to the HP 16500B. To prevent this, you may need to empty the buffer after each command. In C-language, you can use the `flush` function to empty the buffer.

Queries

Responses to queries appear as text strings in the `\system\program` file.

To retrieve information from queries, create a text buffer, open the `\system\program` file and read the contents of the file into the buffer. In C-language, you can use the `read` or `getstr` functions to read the contents of the file into the buffer.

Whenever you send queries to the HP 16500B, you need to pause your program for a short time to allow the system to process the query before you attempt to read the response. A time equal to or slightly greater than the file timeout is sufficient.

Resetting the File Pointer

Whenever you change from reading the `\system\program` file to writing the `\system\program` file, or from writing to reading, you need to reset the file pointer to the beginning of the file. In C-language, you can use the `rewind` function to reset the pointer, or you can close the program file, then immediately re-open it.

Example

The following C-language example opens the \system\program file and sends several commands and queries.

```
#include <stdio.h>
#include <unistd.h>

#define STR_LEN 80

void putstr(file, str)
FILE *file;
char *str;
{
    fwrite(str, strlen(str), 1, file);
}

int getstr(file, str)
FILE *file;
char *str;
{
    return(fread(str, 1, STR_LEN, file));
}

void main()
{
    FILE *file;
    int num;
    char receive_str[STR_LEN];

    /* Send a query and retrieve and print the response */
    file = fopen("/logic/system/program", "r");
    while (getstr(file, receive_str) == 0);
    fclose(file);
    file = fopen("/logic/system/program", "w");
    putstr(file, "*idn?\n");
    fclose(file);
    sleep(1);
    file = fopen("/logic/system/program", "r");
    while (getstr(file, receive_str) == 0);
    fclose(file);
    printf("%s\n", receive_str);
    /* Send command strings to the HP16500B */
    file = fopen("/logic/system/program", "w");
    putstr(file, "*rst\n");
}
```

```
putstr(file, ":sel 9\n");  
putstr(file, ":mach1:twav:range 1 s\n");  
putstr(file, ":start\n");  
putstr(file, ":mach1:twav:range 100 ns\n");  
fclose(file);  
sleep(2);  
file = fopen("/logic/system/program", "r");  
while (getstr(file, receive_str) == 0);  
fclose(file);  
printf("%s\n", receive_str);  
}
```



To write programs that open the command parser socket

- If you are programming in C, open the HP 16500B command parser socket and send programming commands to it.

The HP 16500B command parser socket port identification number is 5025. Connection to the command parser socket is, by definition, a control user connection. Because only one control user connection is allowed, you will not be able to open the command parser socket if someone else is accessing the HP 16500B's file system as the control user.

Example

The following C program opens a SOCKET and sends the *IDN query command to request the instrument's identity.

```
#include <stdio.h>
#include <sys/types.h>
#include <sys/socket.h>
#include <netinet/in.h>

typedef struct sockaddr_in tdSOCKET_ADDR;

#define PARSER_PORT          5025
#define SERV_HOST_ADDR      "15.10.96.12"
#define PARSER_BUFFER_SIZE  100

char  receiveBuffer[PARSER_BUFFER_SIZE],
      *cmdString = { "*IDN?\r\n" };

main ()
{
    int  sockfd, port;
    tdSOCKET_ADDR  serv_addr;
    char  *addr;

    /* Initialize a server socket */
    port = PARSER_PORT;
    addr = SERV_HOST_ADDR ;
    serv_addr.sin_family = AF_INET;
    serv_addr.sin_addr.s_addr = inet_addr ( addr );
```

```
serv_addr.sin_port = htons ( port );

/* Create an endpoint for communication */
sockfd = socket( AF_INET, SOCK_STREAM, 0 );
/* Initiate a connection on the created socket */
connect( sockfd, ( tdSOCKET_ADDR * )&serv_addr, sizeof (
serv_addr ) );
/* Send a message from the created socket */
send ( sockfd, cmdString, strlen ( cmdString ), 0 );
/* Receive a message from the 16500B socket */
recv ( sockfd, receiveBuffer, sizeof ( receiveBuffer ), 0
);
printf ( "%s\n", receiveBuffer );
close ( sockfd );
}
```





Concepts

Concepts

This chapter describes:

- HP 16500B File System Directory Structure.
- Dynamic Files.
- New Menus for HP 16500L.

HP 16500B File System Directory Structure

The HP 16500B directory structure is shown below.

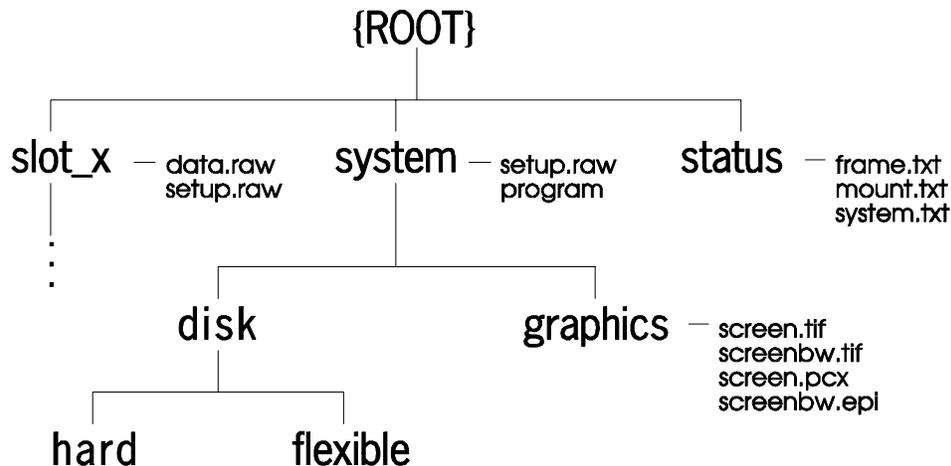

HP 16500B Directory Structure

setup.raw Binary configuration files. You can save and restore configurations by copying these files.

system\program Port for sending programming commands to the command parser.

slot_x Subdirectories for HP 16500B modules.

slot_x\data.raw Binary measurement data files. You can save and restore measurement data by copying these files.

system\disk\hard Same as HP 16500B System Hard Disk.

system\disk\flexible Same as HP 16500B System Flexible Disk.

system\graphics Image files for the current screen in TIFF, PCX, and Encapsulated PostScript formats.

status Status information.

The directory structure of the HP 16500B is fixed. You cannot create or delete directories or files except under the local hard and flexible disk directories.

HP 16550A State/Timing Analyzer Subdirectories and Files

If you are using an HP 16550A 100-MHz state/500-MHz timing analyzer, the `slot_x` directory contains a subdirectory called `data.asc` that contains ASCII measurement data.

There are two subdirectories attached to the `data.asc` directory, one for each of the two analyzers in the HP 16550A (if they are turned on in the Configuration Menu). The default names of these subdirectories are `machine1` and `machine2`, but they will change whenever the analyzer names are changed in the Configuration Menu.

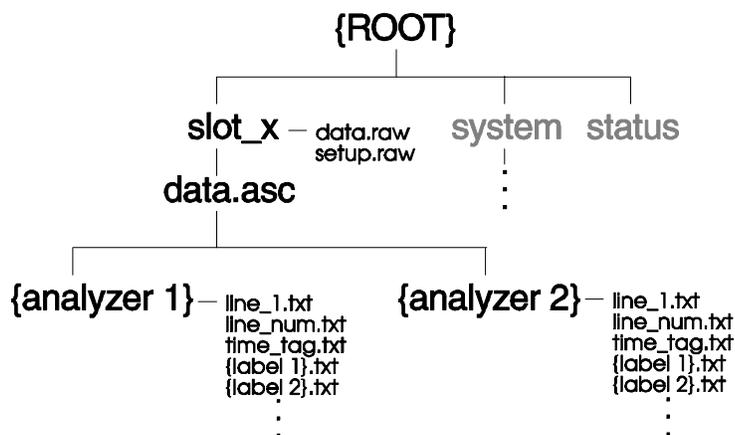

HP 16550A State/Timing Analyzer Directory Structure

Label Data Files: `\slot_x\data.asc\{analyzer name}\{label name}.txt`

Both analyzer subdirectories contain files corresponding to the labels you have set up in that analyzer's Format Menu. These files contain the current measurement data for the channels assigned to each label.

Both state and timing data are available, and both kinds of data are represented as a column of values. The numeric base - hex, binary, etc., in these files is the same as the base that is currently set in the HP 16550A Listing Menu.

The 1st_line.txt File The `1st_line.txt` file lists the number of the first line of the most recent data acquisition.

This file shows the number of states that occur before the trigger state, which is always state zero (at line number 0). You can use this information to align data from different measurements.

Time Tag and State Tag Data If time tags have been turned on, the `time_abs.txt` file contains a column of time values for the most current state or timing measurement.

If state tags have been turned on, the `state_abs.txt` file contains a column of state count values for the most current state measurement.

Line Numbers The `line_num.txt` file contains line numbers corresponding to the lines of data in a state listing.



HP 16542A State Analyzer Subdirectories and Files

If you are using an HP 16542A 2-Mbyte state analyzer, the `slot_x` directory contains a subdirectory called `data.asc` that contains ASCII measurement data.

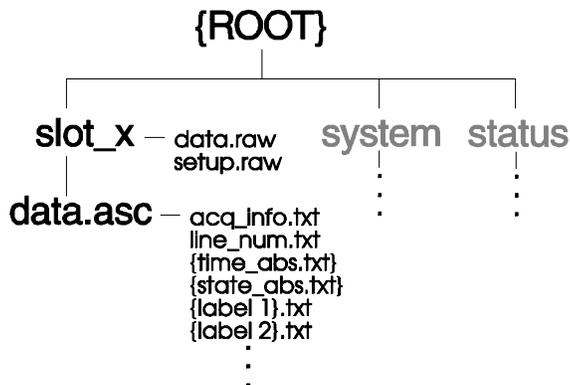

HP 16542A State Analyzer Directory Structure

Label Data Files: `\slot_x\data.asc\{label name}.txt` The `data.asc` subdirectory contains files corresponding to the labels you have set up in your the HP 16542A Format Menu. The files contain the current measurement data for the channels assigned to each label. The numeric base-hex, binary, etc., of the data in these files is the same as the base that is currently set in the Listing Menu.

The `acq_info.txt` File The `data.asc` subdirectory contains a file called `acq_info.txt`. This is an ASCII file that gives you information about the most recent data acquisition.

The contents of the `acq_info.txt` file vary depending on the mode of the acquisition. If the analyzer is in state mode and record mode is not being used, the file will list the line number of the first line of the acquisition and the number of lines in the acquisition:

```
Beginning_line    0
Number_lines     523776
```

If the data was acquired in record mode, the `acq_info.txt` file lists the number of records in the acquisition and the record length:

```
Number_records    255
Record_length     4096
```

If the analyzer is in timing mode, the `acq_info.txt` file lists the line number of the first line and the number of lines, as well as the relative time of the first sample in the acquisition and the sample period:

```
Beginning_line    0
Number_lines      523776
Beginning_time    -3.14e-6
Sample_period     10e-9
```

See Also

The *HP 16542A User's Reference* for more information about data acquisition modes.

Time Tag and State Tag Data If time count feature is turned on, the `time_abs.txt` file contains a column of time values for the most current state or timing measurement.

If state tags have been turned on, the `state_abs.txt` file contains a column of state count values for the most current state measurement.

Line Numbers The `line_num.txt` file contains line numbers corresponding to the lines of data in a state listing.

Inverse-Assembled Data Inverse assembled data is not available through the ASCII data files for the HP 16542A.



Dynamic Files

The HP 16500B's file system uses dynamic files for configuration information and data. This means that applications, such as File Manager or a spreadsheet, cannot determine the size of the files until they are retrieved.

When you view the file statistics for these files in the HP 16500B's file system, you will see file sizes of "0" bytes or "1" byte. The "0" file size indicates that the file is empty. The 1-byte size indicates that there is information in the file. If you transfer the file of interest to your PC or workstation, you will be able to see the actual file size.

Known Incompatibilities

Some operating systems and applications may exhibit unexpected behavior when working with the dynamic files from the HP 16500B. The "% complete" display may appear incorrect during file transfers. This does not affect the transfer or the contents of the file. Once you have saved the file in your local environment, the correct "% complete" will be displayed during future retrievals.

Your applications might only retrieve one or two characters from a file that you believe has many more characters in it. To work around this problem, copy the file that you want to work with from the HP 16500B system to your local computer. Use the local copy as your working copy.

SUN Operating Systems

The file copy commands in the SUN workstation and Solaris operating systems will not work with the dynamic files like those used in the HP 16500B system. You can use the `dd` command instead of using the `cp` or `cat` commands.

New Menus for HP 16500L

When the HP 16500L LAN Interface Module is installed in your HP 16500B mainframe, several new menus or menu choices become available in the HP 16500B. These new fields and menus allow you to set up your LAN port and configure the HP 16500B.

Communications Field

When the HP 16500L LAN Interface Module is installed in your HP 16500B mainframe, the Communications Field in the System Configuration menu now looks like the figure below. The asterisk in this field indicates which I/O port (HP-IB, RS-232C or Ethernet) can control the HP 16500B system remotely using the programming commands described in the *HP 16500B System Programmer's Guide*. When you touch this field, the Communication Configuration menu is displayed.

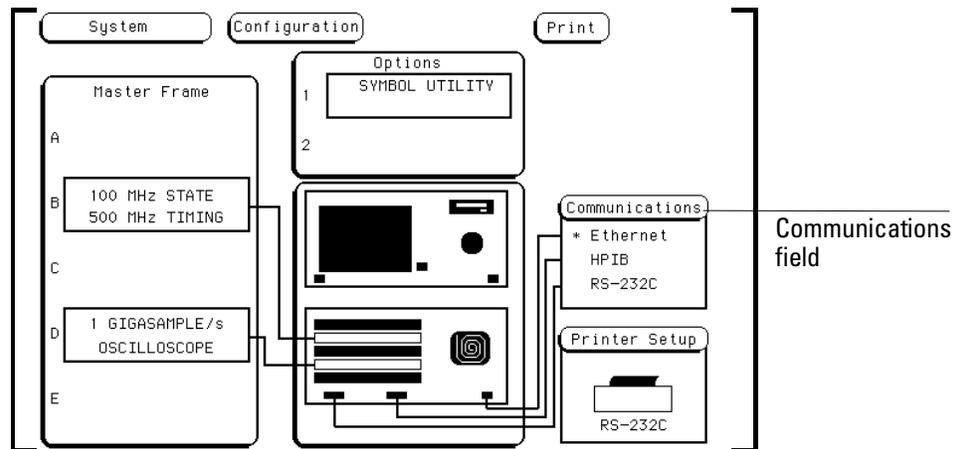

Three new features become available in the Communication Configuration menu. The Controller Selection field now provides "Ethernet" as an additional choice to the standard HP-IB and RS-232C interfaces. There are two new Configuration fields: one labeled "Ethernet", and the other labeled "X Window". The Ethernet configuration menus allow you to set the IP address and change the system name. The X Window configuration menu lets you identify the X server and open and close the HP 16500B's X Window interface.

Concepts
New Menus for HP 16500L

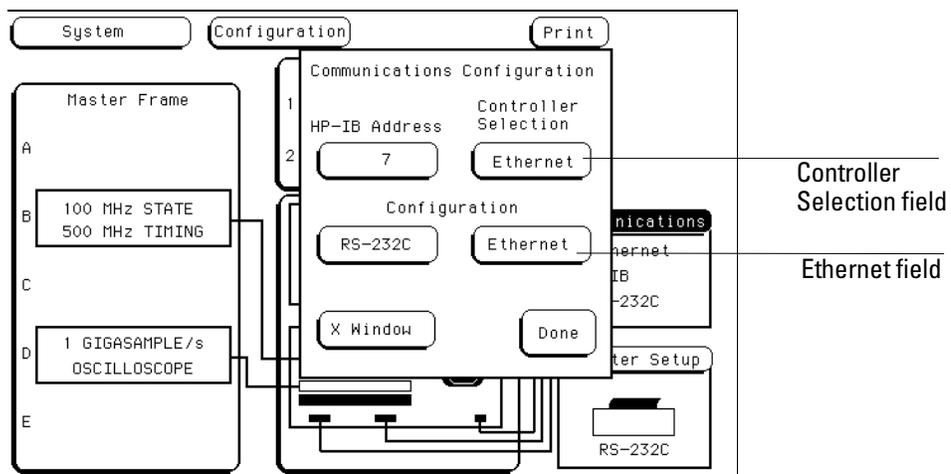

See Also

The *HP 16500L Administrator's and Service Guide* for more information about the LAN configuration and setup menus.

The *HP 16500B System User's Reference* for a detailed explanation of the Communication Configuration menu.

Time Zone Field

When an HP 16500L is installed and the HP 16500B is connected to a LAN, a field labeled "Time Zone" appears in the Real Time Clock setup menu. The Real Time Clock setup menu is accessed by selecting the Real Time Clock Adjustments field in the System Utilities menu.



This field enables you to specify the time difference between your local time and Greenwich Mean Time (Universal Coordinated Time) for network operations. The Time Zone value can be varied from -12 to +12. The number represents the number of hours difference between your local time zone and Greenwich Mean Time. The time value is used to time stamp files when they are stored to disk or transferred to your computer.

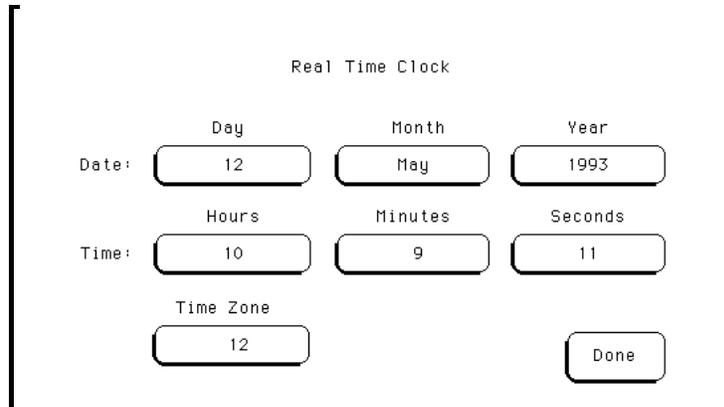





If You Have a Problem

If You Have a Problem

This chapter describes common problems you may encounter when using the HP 16500L LAN Interface Module.

If you cannot connect to the HP 16500B

If you suspect a bad LAN connection between your computer and the HP 16500B, you can verify the network connection by using the `ping` command, the `baF` command, or another, similar echo request utility.

If a bad connection is revealed:

- Make sure power to the HP 16500B is ON.
- Check the physical connection to the LAN.
- Make sure the Internet (IP) Address of the HP 16500B is set up correctly in the Ethernet communications configuration.
- If the HP 16500B and the computer are on different networks or subnets, make sure the Gateway Address in the advanced Ethernet communications configuration is set to the address of the gateway machine. Get the address of gateway machine from your system administrator.

If you cannot mount the HP 16500B file system

If you get a "device busy" message:

- Make sure that another user is not already accessing the file system as the control user or connected to the command parser socket.

If you get a "stale NFS file handle" message:

- Unmount the file system and try mounting again. The like cause of this error is turning OFF power to the HP 16500B before unmounting.

If you get a "server not responding" message:

- If the power to the HP 16500B was just turned ON, make sure that you wait 15 seconds after the System Configuration menu is displayed before attempting the mount.
 - Verify the LAN connection between your computer and the HP 16500B. Refer to "If you cannot connect to the HP 16500B" earlier in this chapter.
- 

If you cannot access the HP 16500B file system via FTP

If you get a "connection refused" message:

- If the power to the HP 16500B was just turned ON, make sure that you wait 15 seconds after the System Configuration menu is displayed before attempting the TELNET.

If you get a "connection timed out" message:

- Verify the LAN connection between your computer and the HP 16500B. Refer to "If you cannot connect to the HP 16500B" earlier in this chapter.

If you get an "already mounted" or "no more mounts available" message:

- If you are trying to access the file system as the control user, try accessing the file system as the data user instead. If another user is

If You Have a Problem
If you cannot start the X Window interface

currently accessing the HP 16500B file system as the control user, you will not be able to access the file system as the control user.

If you cannot start the X Window interface

If you get an "Unable to open window on <IP address>.<display>.<screen>" message:

- Make sure that the HP 16500B has permission to open a window on the X server. For example, you may have to enter an "xhost +<16500 IP address>" command on your X server machine.

If you cannot copy files from HP 16500B

If you can only copy a few bytes of a file:

- Copy the file of interest to your PC or workstation, and use the new, local copy as your working copy. Some applications cannot work directly with the dynamic files from the HP 16500B system.

If you cannot restore raw files

If the setup.raw and data.raw files seem to be ignored when you copy them to the HP 16500B system:

- Verify the LAN connection between your computer and the HP 16500B. Refer to "If you cannot connect to the HP 16500B" earlier in this chapter.
- Change the file time-out. To change the time-out:
 - 1 Access the HP 16500B System Configuration menu.
 - 2 Select the Communications field.
 - 3 Select the Ethernet field under Configuration.
 - 4 Select Advanced Configuration in the Ethernet Configuration pop-up menu.
 - 5 Set the file time out using the File Time-out field in the Advanced Configuration menu.

A value of about 1.5 seconds should be sufficient. Set the time out to the minimum value that will allow network operations to work reliably.

If you cannot TELNET to the command parser SOCKET

If you get a "connection timed out" or "no response from host" message:

- Verify the LAN connection between your computer and the HP 16500B. Refer to "If you cannot connect to the HP 16500B" earlier in this chapter.

If you get a "connection refused" or "no response from host" message:

If you get an "operation timed-out" message

- If the power to the HP 16500B was just turned ON, make sure that you wait 15 seconds after the System Configuration menu is displayed before attempting the TELNET.
- Make sure that another user is not already accessing the file system as the control user or connected to the command parser socket.

If you get an "operation timed-out" message

- Verify the LAN connection between your computer and the HP 16500B. Refer to "If you cannot connect to the HP 16500B" earlier in this chapter.
- Increase the file time-out value on your PC or workstation.

If the HP 16500B begins to operate slowly

The HP 16500B may operate more slowly if multiple users are trying to use the system at the same time.

- Copy the file `\system\mount.txt` to your local computer and view it with a text editor. Check to see whether any other users are currently connected to the system.

If all else fails

- Contact your system administrator, or consult the *HP 16500L LAN Interface Module Administrator's and Service Guide*.
- If you still cannot solve the problem, contact the nearest HP Service Center for repair information.

Glossary

Client A computer or program that is configured to use services provided by another computer on a network. The HP 16500B does not have client capabilities.

Ethernet A network that adheres to the IEEE 802.3 Local Area Network standard.

Ethernet Address A hexadecimal number which is used to identify a machine on a network. Each HP 16500B is assigned a unique Ethernet address.

FTP (File Transfer Protocol) A service that allows you to remotely transfer files among different operating systems.

Host A computer on a network. When controlling the HP16500B, your computer is considered the host.

host name A unique name that is used to identify each host machine on a network. The host name is created by the user or system administrator.

IP Address (Internet Protocol Address) A unique number that is assigned to a each device which is to be connected to a TCP/IP network. Before using your HP 16500B, you or

your system administrator will need to assign an IP address.

mount The method used in NFS and other network protocols to gain access to a network's resources. UNIX systems use a "mount" command. DOS systems typically use a "net use" command.

NFS (Networked File System) A distributed file system that allows data to be shared by computers on a network, regardless of operating system, network architecture or protocol. The NFS protocol also allows you to move files between networks and operating systems.

ping A utility that allows you to determine the status of the connections between devices and a network. The ping utility is usually included with software packages that provide NFS services.

protocol A set of conventions that specify how information will be formatted and transmitted on a network, and how machines on a network will communicate.

Server A device that is configured to provide a service to other devices on network, such as shared access to a file system or printer. The HP 16500B acts like a server on your network.

Glossary

system administrator A person who manages systems and machines on a network. The system administrator is responsible for installing software and hardware on the network and assigning addresses and names to machines.

TCP/IP (Transmission Control Protocol/Internet Protocol) A set of standards for communications between computers and between networks.

telnet A protocol that allows users to create a session to run programs on or transfer information to and from a remote computer.

time out A period of system inactivity during which the system awaits user or network response. If there is no response by the end of the period, the system takes an action. In the HP 16500B, the file timeout function in the Ethernet Configuration menu is used to set the time out period.

X Window System An open system technology that uses a windows environment and makes possible the distribution of graphical applications across networks. X is a network graphics protocol which is hardware independent, operating system inde-

pendent, network transparent, portable and extensible.

Index

I

0-byte file size, 6-8
1-byte file size, 6-8
100-MHz state/500-MHz timing analyzer subdirectories and files, 6-4
1st_line.txt file, 6-5
2-Mbyte state analyzer subdirectories and files, 6-6

A

acq_info.txt file, 6-6
already mounted message, 7-3
anomalies, X window display, 2-14
ASCII command files, 5-7
ASCII measurement data, copying, 3-3 to 3-4

B

baf command, 7-2

C

C-language programs, 5-9 to 5-11
command parser socket, 5-3
commands, programming, 5-2
communications field, 5-5, 6-9
configurations (HP 16500B module), 4-2
configurations (HP 16500B module), copying, 4-3
configurations (HP 16500B module), restoring, 4-4
connection problems, 7-2
connection refused message, 7-3, 7-5
connection timed out message, 7-3, 7-5
control user, 1-4, 1-6, 1-9, 3-11, 5-3
control user vs. data user, 1-2
controller selection, 5-4 to 5-5, 6-9
cp command on SUN operating systems, 6-8
custom fonts for X Window interface, loading, 2-11 to 2-13

D

data (ASCII measurement), copying, 3-3 to 3-4
data (raw measurement), copying, 3-5
data (raw measurement), file format, 3-7
data (raw measurement), restoring, 3-6
data user, 1-4, 1-6, 1-9, 3-11

data user vs. control user, 1-2
data, HP 16542A, 6-6
data, HP 16550A, 6-4
data.asc subdirectory, 6-4, 6-6
data.raw files, 7-5
device busy message, 7-3
directory structure, HP 16500B file system, 6-3 to 6-7
displays, copying screen image files, 3-9 to 3-10
drive name, logical, 1-6 to 1-7
dynamic files, 6-8
dynamic files, problems with SUN operating systems, 6-8

E

echo command, 5-7
Encapsulated PostScript format screen image files, copying, 3-9 to 3-10
Ethernet communications, setting HP 16500B up for, 5-4 to 5-5

F

File Manager, 1-7
file pointer, \system\program, 5-9
file protection, 1-3
file size, 6-8
file system (HP 16500B), accessing, 1-2
file system (HP 16500B), directory structure, 6-3 to 6-7
first line of acquisition, 6-5 to 6-6
fonts for X Window interface, loading, 2-11 to 2-13
formats of screen image files, 3-9 to 3-10
frame.txt status file, 3-11
front-panel knob movement, duplicating, 2-3
FTP, accessing the HP 16500B file system, 1-9

G

Gateway Address, 7-2
graphics files, copying, 3-9 to 3-10

H

HP 16500B file system directory structure, 6-3 to 6-7
HP 16500B file system, accessing, 1-2
HP 16500B file system, accessing via FTP, 1-9
HP 16500B file system, mounting, 7-3
HP 16500B file system, mounting via NFS, 1-4 to 1-8
HP 16500B X Window interface, 2-2
HP 16500B X Window interface, closing, 2-9 to 2-10
HP 16500B X Window interface, loading custom fonts, 2-11 to 2-13
HP 16500B X Window interface, starting, 2-4 to 2-8
HP 16500B, LAN configuration menus, 6-9
HP 16500B, programming, 5-2
HP 16500B, setting time zone, 6-11
HP 16542A data files, 6-6
HP 16542A labels, 6-6
HP 16542A subdirectories and files, 6-6
HP 16542A time tags, 6-7
HP 16542A, acquisition information, 6-6
HP 16542A, inverse-assembled data, 6-7
HP 16542A, line numbers, 6-7
HP 16550A data files, 6-4
HP 16550A labels, 6-4
HP 16550A line numbers, 6-5
HP 16550A state/timing analyzer, copying ASCII data, 3-4
HP 16550A subdirectories and files, 6-4
HP 16550A, setting up the analyzer, 4-4

I

Intermodule Bus configuration, 4-3 to 4-4

K

keyboard, using, 2-2
knob (front-panel) movement, duplicating, 2-3

L

label names, 6-4, 6-6
last line of acquisition, 6-6
limitations (real-time) of programming over the LAN, 5-2

-
- line numbers of an acquisition, 6-5, 6-7
line_num.txt file, 6-5, 6-7
logical drive name, 1-6 to 1-7
login name, FTP access, 1-9
- M**
measurement data (ASCII), copying, 3-3 to 3-4
measurement data (raw), copying, 3-5
measurement data (raw), file format, 3-7
measurement data (raw), restoring, 3-6
measurement modules, HP 16542A, 6-6
measurement modules, HP 16550A, 6-4
menus, new for in the HP 16500L, 6-9 to 6-11
module configurations (HP 16500B), copying, 4-3
module configurations (HP 16500B), restoring, 4-4
modules (HP 16500B) supported in X Window interface, 2-2
modules (HP 16500B), configuring, 4-2
mount.txt status file, 3-11
mouse, using, 2-2
MS Windows
 File Manager, 1-7
MS Windows, mounting the HP 16500B file system, 1-7
MS-DOS, mounting the HP 16500B file system, 1-6
- N**
NFS, mounting the HP 16500B file system, 1-4 to 1-8
no more mounts available message, 7-3
no response from host, 7-5
ntermodule status, 3-11
- O**
operation timed out message, 7-6
- P**
password protection, 1-3
password, FTP access, 1-9
PCX format screen image files, copying, 3-9 to 3-10
ping command, 7-2
port ID number for HP 16500B command parser socket, 5-6, 5-12 to 5-13
PostScript format screen image files, copying, 3-9 to 3-10
prerequisites, 1-ii
program file, 5-2
program file, copying commands to, 5-7 to 5-8
programming commands, 1-2, 5-2
programming, setting up the HP 16500B for, 5-4 to 5-5
programs that write to \system\program, 5-9 to 5-11
- Q**
queries by program commands, 5-9
- R**
raw measurement data, copying, 3-5
raw measurement data, file format, 3-7
raw measurement data, restoring, 3-6
read-only access to HP 16500B file system, 1-2
read-write access to HP 16500B file system, 1-2
real-time limitations of programming over the LAN, 5-2
relative trigger time, 3-11
requirements, 1-ii
- S**
screen image files, copying, 3-9 to 3-10
server not responding message, 7-3
setup.raw files, 7-5
setup.raw files, copying, 4-3
setup.raw files, restoring, 4-4
size of files, 6-8
slow operation, 7-6
socket, HP 16500B command parser, 5-3, 5-12 to 5-13
socket, port ID number, 5-6, 5-12 to 5-13
stale NFS file handle, 1-4 to 1-8
stale NFS file handle message, 7-3
state analyzer (HP 16542A), subdirectories and files, 6-6
state tags, HP 16542A, 6-7
state tags, HP 16550A, 6-5
state/timing analyzer (HP 16550A), copying ASCII data, 3-4
state/timing analyzer (HP 16550A), subdirectories and files, 6-4
status information (HP 16500B), copying, 3-11 to 3-12
SUN workstations, 6-8
system configuration, 4-3 to 4-4
system.txt status file, 3-11
- T**
text files containing data, 6-4, 6-6
TIFF format screen image files, copying, 3-9 to 3-10
time out, 7-5 to 7-6
time tags, HP 16542A, 6-7
time tags, HP 16550A, 6-5
time zone, 6-11
time_abs.txt file, 6-5, 6-7
- U**
unable to open window message, 7-4
UNIX, mounting the HP 16500B file system, 1-4
- V**
versions of operating system code for modules, 3-11
- X**
X window display anomalies, 2-14
X Window interface (HP 16500B), 2-2
X Window interface (HP 16500B), closing, 2-9 to 2-10
X Window interface (HP 16500B), loading custom fonts, 2-11 to 2-13
X Window interface (HP 16500B), starting, 2-4 to 2-8
X Window interface, supported HP 16500B modules, 2-2
xhost command, 7-4
-

© Copyright Hewlett-Packard Company 1987, 1990, 1993, 1994
All Rights Reserved.

Reproduction, adaptation, or translation without prior written permission is prohibited, except as allowed under the copyright laws.

Document Warranty

The information contained in this document is subject to change without notice.

Hewlett-Packard makes no warranty of any kind with regard to this material, including, but not limited to, the implied warranties of merchantability or fitness for a particular purpose.

Hewlett-Packard shall not be liable for errors contained herein or for damages in connection with the furnishing, performance, or use of this material.

Safety

This apparatus has been designed and tested in accordance with IEC Publication 348, Safety Requirements for Measuring Apparatus, and has been supplied in a safe condition. This is a Safety Class I instrument (provided with terminal for protective earthing). Before applying power, verify that the correct safety precautions are taken (see the following warnings). In addition, note the external markings on the instrument that are described under "Safety Symbols."

Warning

- Before turning on the instrument, you must connect the protective earth terminal of the instrument to the protective conductor of the (mains) power cord. The mains plug shall only be inserted in a socket outlet provided with a protective earth contact. You must not negate the protective action by using an extension cord (power cable) without a protective conductor (grounding). Grounding one conductor of a two-conductor outlet is not sufficient protection.
- Only fuses with the required rated current, voltage, and specified type (normal blow, time delay, etc.) should be used. Do not use repaired fuses or short-circuited fuseholders. To do so could cause a shock or fire hazard.

- Service instructions are for trained service personnel. To avoid dangerous electric shock, do not perform any service unless qualified to do so. Do not attempt internal service or adjustment unless another person, capable of rendering first aid and resuscitation, is present.

- If you energize this instrument by an auto transformer (for voltage reduction), make sure the common terminal is connected to the earth terminal of the power source.

- Whenever it is likely that the ground protection is impaired, you must make the instrument inoperative and secure it against any unintended operation.

- Do not operate the instrument in the presence of flammable gasses or fumes. Operation of any electrical instrument in such an environment constitutes a definite safety hazard.

- Do not install substitute parts or perform any unauthorized modification to the instrument.

- Capacitors inside the instrument may retain a charge even if the instrument is disconnected from its source of supply.

- Use caution when exposing or handling the CRT. Handling or replacing the CRT shall be done only by qualified maintenance personnel.

Safety Symbols



Instruction manual symbol: the product is marked with this symbol when it is necessary for you to refer to the instruction manual in order to protect against damage to the product.



Hazardous voltage symbol.



Earth terminal symbol: Used to indicate a circuit common connected to grounded chassis.

WARNING

The Warning sign denotes a hazard. It calls attention to a procedure, practice, or the like, which, if not correctly performed or adhered to, could result in personal injury. Do not proceed beyond a Warning sign until the indicated conditions are fully understood and met.

CAUTION

The Caution sign denotes a hazard. It calls attention to an operating procedure, practice, or the like, which, if not correctly performed or adhered to, could result in damage to or destruction of part or all of the product. Do not proceed beyond a Caution symbol until the indicated conditions are fully understood or met.

Product Warranty

This Hewlett-Packard product has a warranty against defects in material and workmanship for a period of one year from date of shipment. During the warranty period, Hewlett-Packard Company will, at its option, either repair or replace products that prove to be defective.

For warranty service or repair, this product must be returned to a service facility designated by Hewlett-Packard.

For products returned to Hewlett-Packard for warranty service, the Buyer shall prepay shipping charges to Hewlett-Packard and Hewlett-Packard shall pay shipping charges to return the product to the Buyer. However, the Buyer shall pay all shipping charges, duties, and taxes for products returned to Hewlett-Packard from another country.

Hewlett-Packard warrants that its software and firmware designated by Hewlett-Packard for use with an instrument will execute its programming instructions when properly installed on that instrument.

Hewlett-Packard does not warrant that the operation of the instrument software, or firmware will be uninterrupted or error free.

Limitation of Warranty

The foregoing warranty shall not apply to defects resulting from improper or inadequate maintenance by the Buyer, Buyer-supplied software or interfacing, unauthorized modification or misuse, operation outside of the environmental specifications for the product, or improper site preparation or maintenance.

No other warranty is expressed or implied. Hewlett-Packard specifically disclaims the implied warranties of merchantability or fitness for a particular purpose.

Exclusive Remedies

The remedies provided herein are the buyer's sole and exclusive remedies. Hewlett-Packard shall not be liable for any direct, indirect, special, incidental, or consequential damages, whether based on contract, tort, or any other legal theory.

Assistance

Product maintenance agreements and other customer assistance agreements are available for Hewlett-Packard products.

For any assistance, contact your nearest Hewlett-Packard Sales Office.

Certification

Hewlett-Packard Company certifies that this product met its published specifications at the time of shipment from the factory. Hewlett-Packard further certifies that its calibration measurements are traceable to the United States National Institute of Standards and Technology, to the extent allowed by the Institute's calibration facility, and to the calibration facilities of other International Standards Organization members.

About this edition

This is the second edition of the *HP 16500L User's Guide*.

Publication number
16500-97008

Printed in USA.

Edition dates are as follows:

First edition, June 1993

Second edition, April 1994

New editions are complete revisions of the manual. Update packages, which are issued between editions, contain additional and replacement pages to be merged into the manual by you. The dates on the title page change only when a new edition is published.

A software or firmware code may be printed before the date. This code indicates the version level of the software or firmware of this product at the time the manual or update was issued. Many product updates do not require manual changes; and, conversely, manual corrections may be done without accompanying product changes. Therefore, do not expect a one-to-one correspondence between product updates and manual updates.

The following list of pages gives the date of the current edition and of any changed pages to that edition.

All pages original edition